

Features

- High performance; low THD
- Flicker free; high PF
- Suitable for Class II light fixtures
- 5-year warranty (please refer to the warranty condition)



Applications

· Commercial lighting · indoor office lighting · decorative lighting · residential lighting

Descriptions

LF-GIT040YA is a 40W isolated constant current flicker-free LED driver. Its input voltage ranges from 220-240V and its output voltage ranges from 9-42V. Its output current is adjustable from 300-1050mA via DIP switch with every 50mA as a step. It is suitable for Class II light fixtures, including integrated track lighting.

Product Model

LF - GIT 040 YA



- Y: complies with certifications; A: serial number
- 040: max. output power: 40W
- G: isolated design; IT: integrated track

■ Electrical Characteristics

Model		LF-GIT040YA																
Output	Output Voltage	9-42V																
	Output Current	300 mA	350 mA	400 mA	450 mA	500 mA	550 mA	600 mA	650 mA	700 mA	750 mA	800 mA	850 mA	900 mA	950 mA	1000 mA	1050 mA	
	Flicker Index	Complies with IEEE 1789-2015 standard																
	CIE SVM	≤0.4																
	IEC-Pst	≤1																
	Current Tolerance	±6%																
	Temperature Drift	±10%																
Input	AC Input Voltage	220-240Vac (voltage limit: 198-264Vac)																
	DC Input Voltage	220-240Vdc (voltage limit: 180-264Vdc)																
	Input Frequency	0/50/60Hz																
	Input Current	0.28A max.																
	PF	≥0.87				≥0.9				≥0.95								
	THD	≤20%																
	Efficiency	≥86.5%				≥88%				≥88.5%								
	Inrush Current	≤20A@10uS																
	Loading Quantities of Circuit Breaker	Model	B10				C10				B16				C16			
		Quantity (pcs)	25				25				40				40			
	Leakage Current	≤0.7mA																
Standby Power Consumption	≤0.5W																	
Protection Characteristics	Open Circuit	<55V																
	Short Circuit	Hiccup mode (auto-recovery)																
Environment Descriptions	Operating Temperature	-20°C - +35°C																
	Operating Humidity	20-90%RH (no condensation)																
	Storage Temperature/ Humidity	-30°C - 80°C (6 months in Class I environment); 10-90%RH (no condensation)																
	Atmospheric Pressure	86-106kPa																

■ Electrical Characteristics

Safety & EMC	Certifications	ENEC, CE, CB, RCM, UKCA, EAC
	Withstand Voltage	I/P-O/P: 3.75kV 5mA 60S
	Insulation Resistance	I/P-O/P: >100MΩ@500Vdc
	Safety Standards	ENEC: EN61347-1:2015, EN 61347-2-13:2014/A1:2017, EN 62384: 2016/A1:2009 CE-LVD: EN 61347-2-13:2014/A1:2017, EN 61347-1:2015, EN 62493:2015 UKCA-LVD:EN 61347-1:2015/A1:2021, EN 61347-2-13:2014/A1:2017 EN 62493:2015 RCM:AS 61347.2.13:2018 & AS/NZS 61347.1:2016+A1
	EMI	CE-EMC/RCM: EN55015, EN61000-3-2, EN61000-3-3
	EMS	CE-EMC/RCM: EN61000-4-2, 3, 4, 5 (lightning strike 1kV), 6, 11
Other Parameters	IP Rating	IP20
	RoHS	RoHS 2.0 (EU) 2015/863
	Warranty	5 years (Tc≤81°C)
Test Equipment	AC power source: CHROMA6530, digital power meter: CHROMA66202, oscilloscope: Tektronix DPO3014, DC electronic load: M9712B, LED board, constant temperature and humidity chamber, lightning surge generator: Everfine EMS61000-5B, rapid group pulse generator: Everfine EMS61000-4A, spectroanalyzer: KH3935, hi-pot tester: EEC SE7440, flicker tester (flicker-free coefficient test) Everfine LFA-3000, etc.	
Test Remark	If there are no special remarks, the above parameters are tested at the ambient temperature of 25°C, humidity of 50%, full load and input voltage of 230Vac/50Hz.	

Electrical Characteristics

Additional Remarks	<ol style="list-style-type: none"> 1. It is recommended that user install over voltage protection, under voltage protection and surge protection devices in the power supply circuits of light fixtures to ensure electricity safety. 2. The PC cover, casing and end cap for assembling the LED driver in the light fixture must meet the fire rating of UL94-V0 or above. 3. The LED driver used in combination with the end device is one of the accessories of the whole light fixture, and the EMC of the whole light fixture is not only susceptible to the driver itself, but to the LED light fixture and the whole light fixture's wiring. Thus, the manufacturer of LED light fixture should re-confirm the EMC of the whole light fixture before the whole light fixture is finished. 4. The test conditions of the circuit breaker configuration quantity are the same as those of the inrush current.
---------------------------	--

Product Characteristic Curves

PF Curve

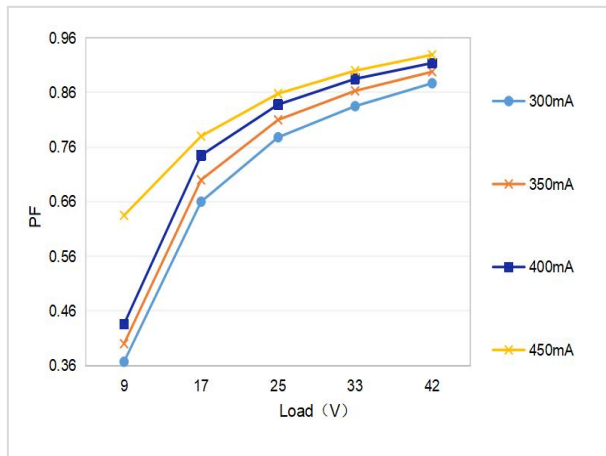

Efficiency Curve

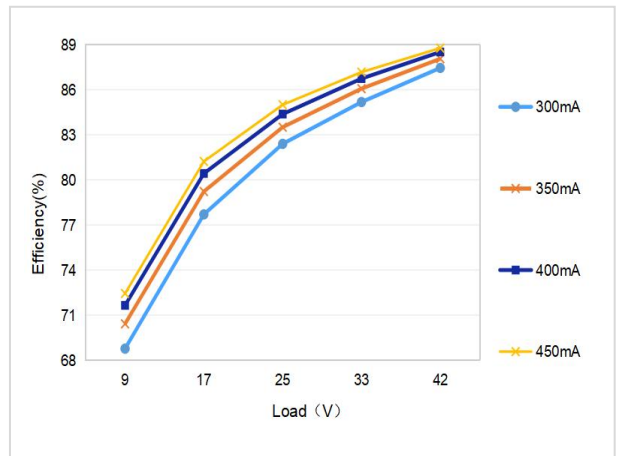

PF

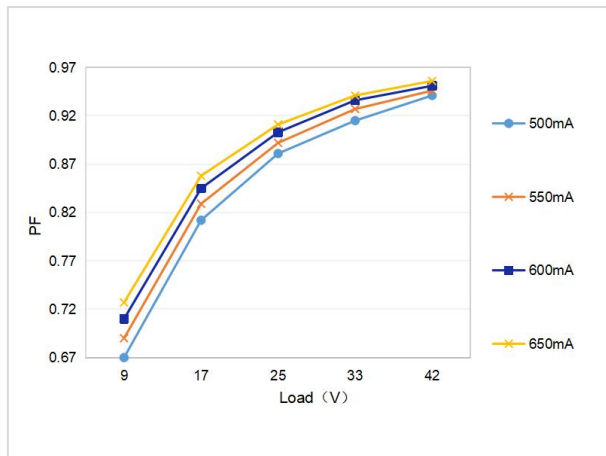

Efficiency (%)

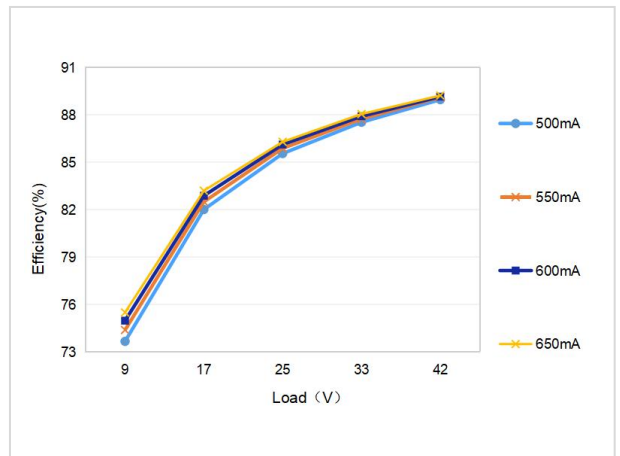

■ Product Characteristic Curves

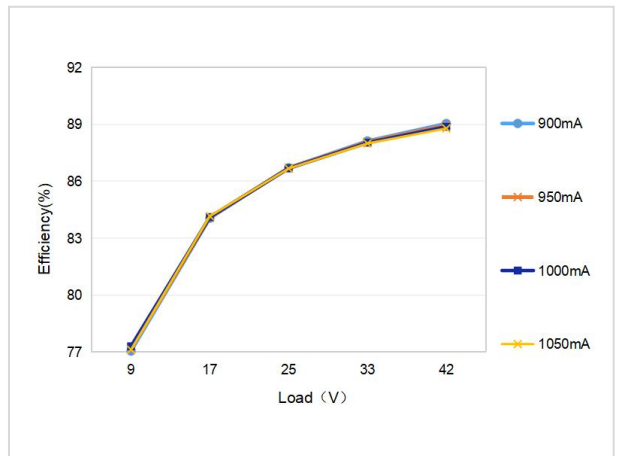
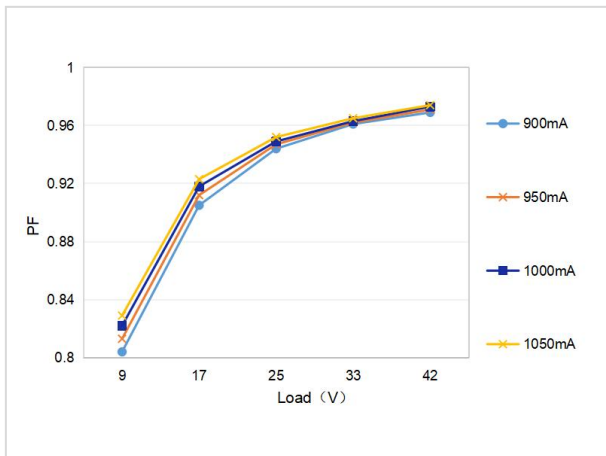
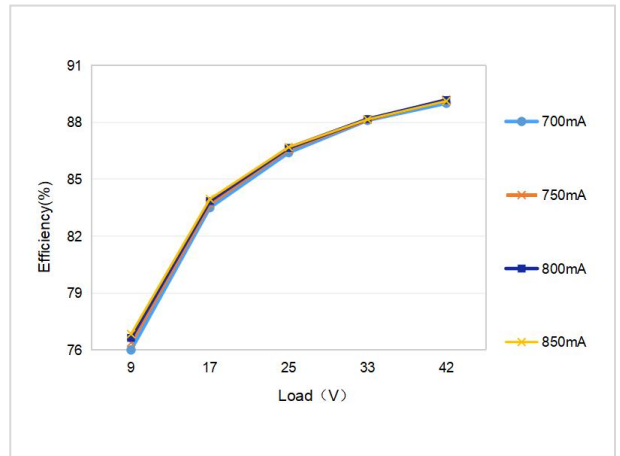
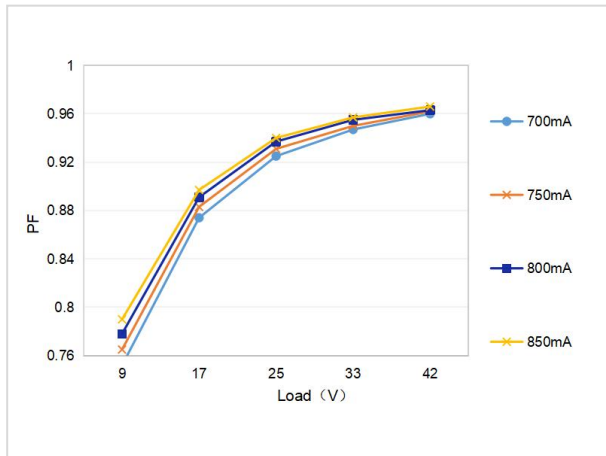

Lifetime Curve

Tc Point Test Diagram

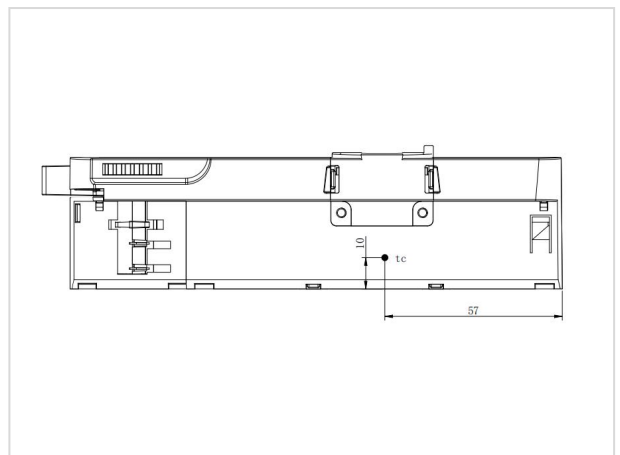
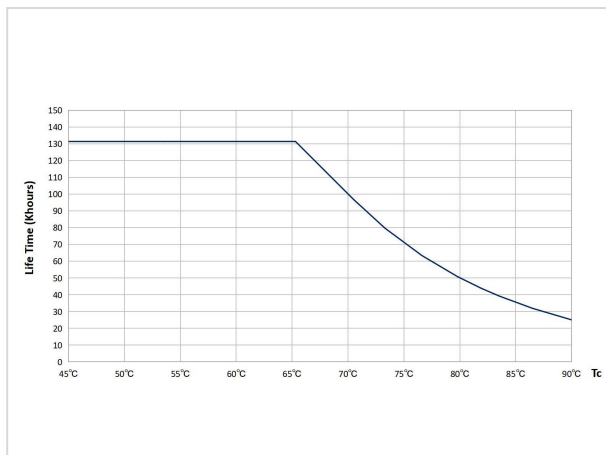

■ Product Definitions

Product Terminals

INPUT		OUTPUT	
AC-L	AC live wire input	LED+	Positive electrode output of LED driver
AC-N	AC neutral wire input	LED-	Negative electrode output of LED driver

Product DIP Switch

I rated (CC)	1	2	3	4
300mA	-	-	-	-
350mA	-	-	-	ON
400mA	-	-	ON	-
450mA	-	-	ON	ON
500mA	-	ON	-	-
550mA	-	ON	-	ON
600mA	-	ON	ON	-
650mA	-	ON	ON	ON
700mA	ON	-	-	-
750mA	ON	-	-	ON
800mA	ON	-	ON	-
850mA	ON	-	ON	ON
900mA	ON	ON	-	-
950mA	ON	ON	-	ON
1000mA	ON	ON	ON	-
1050mA	ON	ON	ON	ON

Remark: "-": shift OFF

Lifud Technology Co., Ltd.

Production Base I (HQ): Building B, Kutto Industrial Park, NO.26 Xinhe Road, Bao'an District, Shenzhen, China.

Production Base II: No.4, Block 2, Tengfei Road, Shigao Economic Development Zone, Tianfu New Area, Sichuan, China.

Website: www.lifud.com

Telephone: +86(0)755 8373 9299

Email: sales@lifud.com

■ **Product Application Track**

Number	Brand	Track Type	Phase Position
1	Global	XTS 4 & XTSF 4	3P
2	Eutrac	2510x	3P
3	Ivela	7501	3P
4	Unipro	T32B	3P
5	Stucchi	9000XX Series	3P

■ **Diagram of a 4-Wire, 3-Circuit Track**

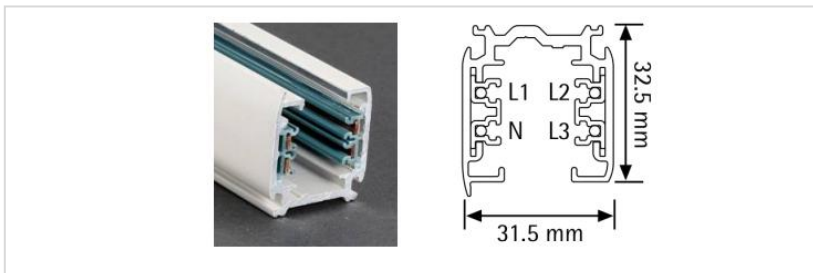

■ **Structure & Dimensions (unit: mm)**

Product Dimensions

Model	Overall Appearance (L*W*H)	Distance Between 2 Positioning Holes (L)	Diameter of Positioning Hole (D)
LF-GIT040YA	158.1*42.2*31.1mm (±0.5mm)	26.1mm (±0.2mm)	3.1mm

Structure Diagrams

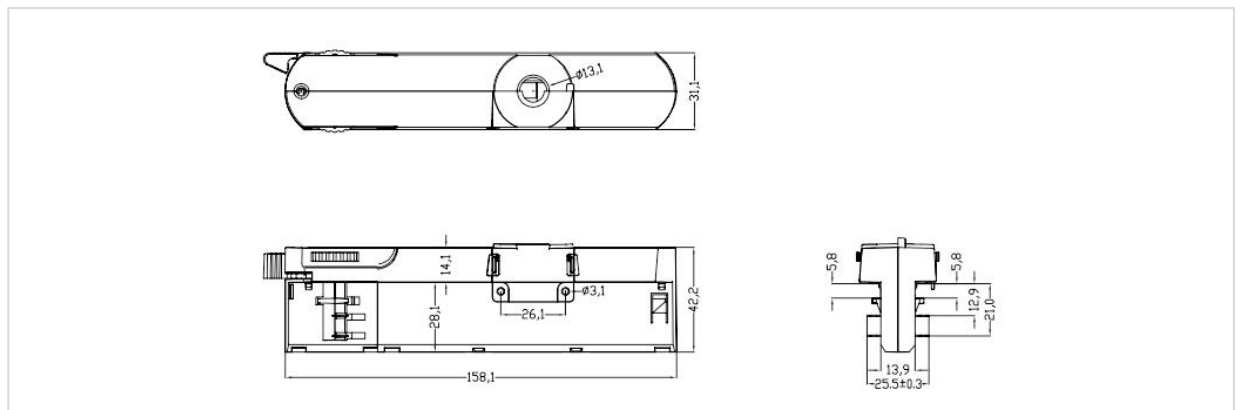

■ Packaging Specifications

Model	LF-GIT040YA
Carton Size	385*285*210mm (L*W*H)
Quantity	12 pcs/layer; 4 layers/ctn; 48 pcs/ctn
Weight	0.12±5% kg/pc; 7.0±5% kg/ctn

■ Transportation & Storage

1. Transportation

- Suitable transportation means: vehicles, boats and aeroplanes.
- In transit, it is necessary to prepare awnings for rain or sun protection. Moreover, please keep civilized loading and unloading to prevent the vibration or impact of LED driver as much as possible.

2. Storage

- The storage of LED driver shall conform to the standard of Class I environment. When using LED drivers which have been stored for more than 6 months, please re-test them firstly. Do not use them unless they are tested to be qualified.

Cautions

- Please use Lifud LED driver according to its parameters in the specification, otherwise the LED driver may malfunction.
- Using any incompatible light fixtures or those that have not been certified may cause fire, explosion or other risks.
- Man-made damage is beyond the scope of Lifud warranty service.

Remark: Lifud Technology Co., Ltd. reserves the right to interpret any contents of this specification.